



ZIPPY TECHNOLOGY CORP.



10F, NO.50, MIN CHYUAN ROAD,
SHIN-TIEN CITY, TAIPEI COUNTY,
TAIWAN, R.O.C

TEL: 886-2-2918-8512 / 886-2-2918-0603
FAX: 886-2-2915-5765 / 886-22916-0215
[Http://www.zippy.com.tw](http://www.zippy.com.tw)

APPROVED DATA SHEET

Model: 1000100219(DF-03S-25P-Z)

ISSUED DATE: 2020.04.27
APPROVED NO.: 1000100219.G
PAGE: 1/5

The undersigned guarantee of the model switches is meets the following specifications.

1. Operation Characteristics

Operating Force (OF) : Max.65 gf
Releasing Force (RF) : Min.10 gf
Free Position (FP) : Max.16.55 mm
Operating Position (OP) : 13.65±1.0 mm
Movement Differential (MD) : Max.1.0 mm
Over-travel (OT) : Min.0.5 mm
Pre-travel (PT) : Max.3.9 mm

2. Specifications

Initial Contact Resistance : Max. 100 mΩ .
(Measured by ohm meter –Open Voltage<1VDC, Driver current -100mA)
Before measure the switch contact resistance, please press the switch three times on and off.

Initial Dielectric Strength : 1,000VAC(50-60HZ)/minute between contacts.
1,500VAC(50-60HZ)/minute between Live-parts and dead metal parts.

Insulation Resistance : Min. 100 MΩ (500 VDC/ minute) between Live-parts and dead metal parts.

Circuit Arrangement : SPDT (Single pole double throw)

Rating : 3A 125VAC; 3A 24VDC

Service Life : Min. 10,000 operations

Rating Load : Resistive Load

Operating Frequency : 10~30 operations per minute

Safety Certificate : UL, cUL, ENEC

Mechanical Service Life : Min. 1,000,000 operations.

Operating Frequency : Max. 120 operations per minute.

Operating application of the switch : Set the switch pushing distance from 60% to 90% of the specified OT value.



ZIPPY TECHNOLOGY CORP.



10F, NO.50, MIN CHYUAN ROAD,
SHIN-TIEN CITY, TAIPEI COUNTY,
TAIWAN, R.O.C

TEL: 886-2-2918-8512 / 886-2-2918-0603
FAX: 886-2-2915-5765 / 886-22916-0215
[Http://www.zippy.com.tw](http://www.zippy.com.tw)

APPROVED DATA SHEET

Model: 1000100219(DF-03S-25P-Z)
=====

ISSUED DATE: 2020.04.27
APPROVED NO.: 1000100219.G
PAGE: 2/5

3. Environments

- Operating Temperature : -40°C ~ 85°C (with no icing)
- Vibration Resistance : 10~55Hz, displacement 0.75mm(p-p)
- Shock Resistance : Destruction: 1,000 m/s² {approx. 100G} max.

(For the pin plunger models, the vibration & shock condition apply for use at the free position and total travel position)
(For the lever models, the vibration & shock condition apply for use at the total travel position)

- Soldering by hand : 260°C maximum within 5 seconds.
300°C maximum within 3 seconds.
- Soldering bath : 260°C maximum within 5 seconds. (PCB thickness more than Min 1.6 mm.)

ZIPPY TECHNOLOGY CORP.
簡永鎮

PREPARED
歐大揮

CHECKED
倪有庭

APPROVED

Dimensions drawing

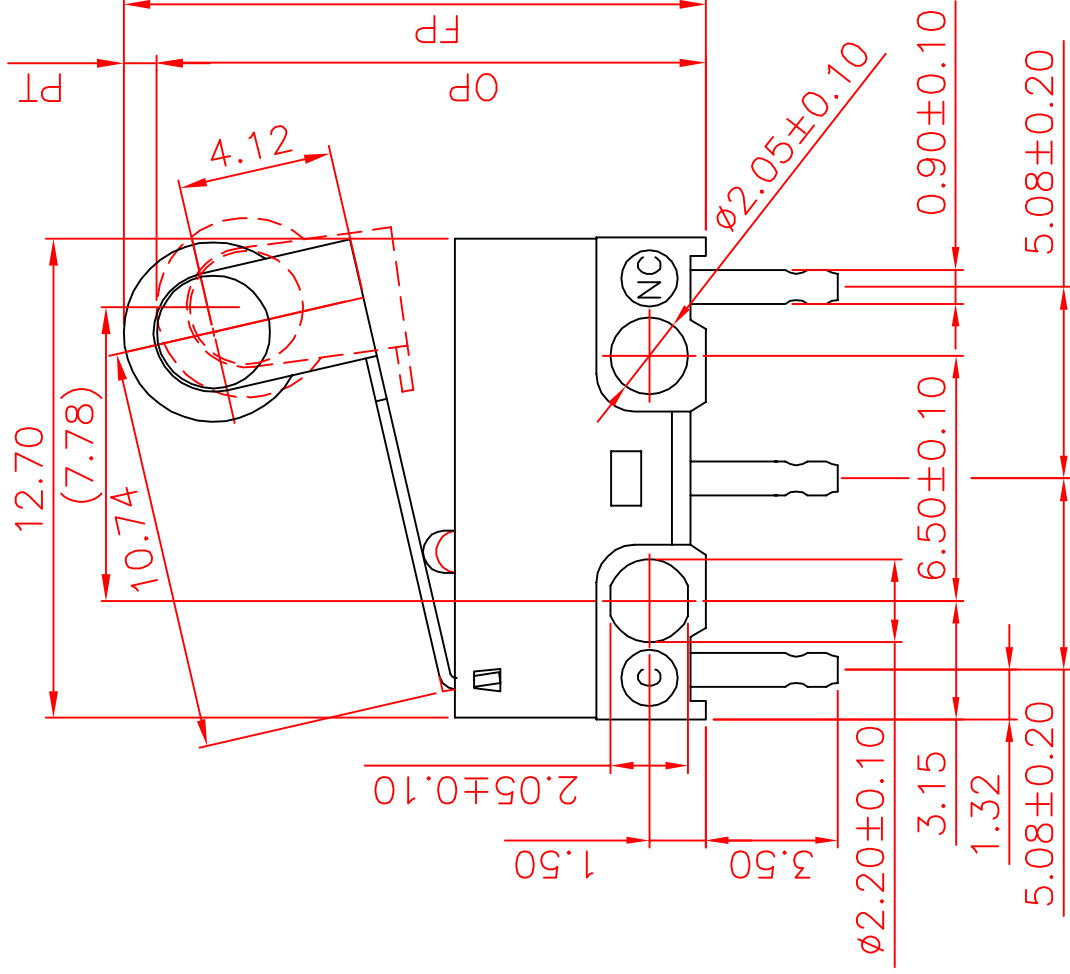
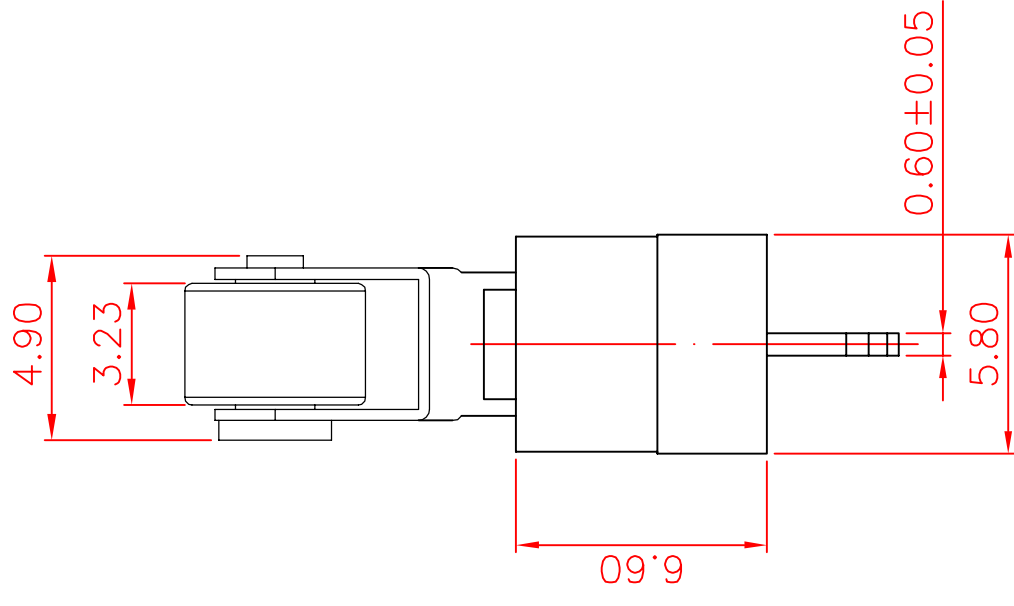
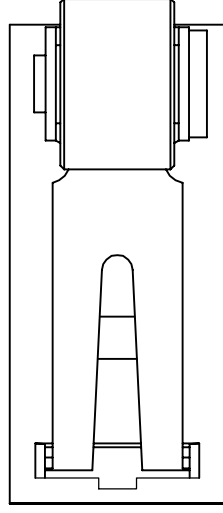

Tolerance

XX ±0.2

XXX ±0.4

VIEW	DATE	APPROVAL	SIZE	UNIT
	JUL.09.2013	李金龍	A4	mm
FILE NAME	VER.	DESIGN	CONFIRM	
DF-25P0	1.3	張哲維		
DESIGN	CONFIRM	林立凱		

Marking drawing

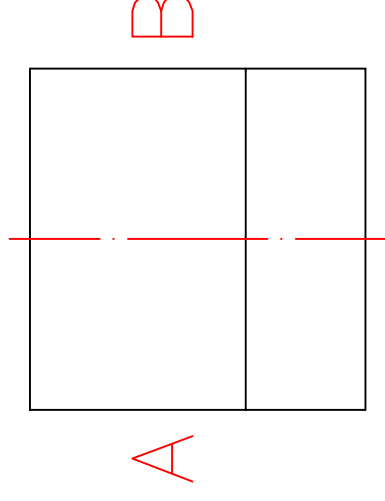
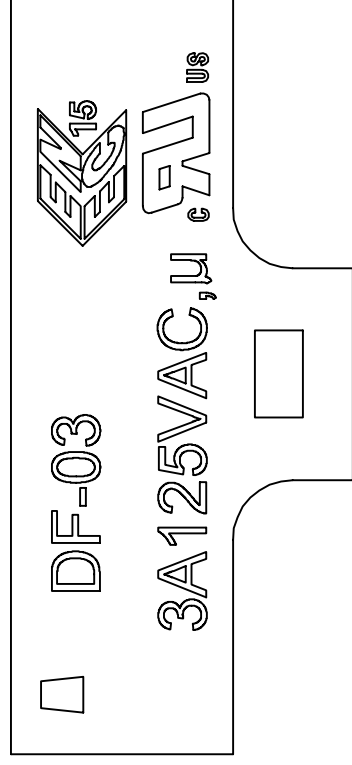
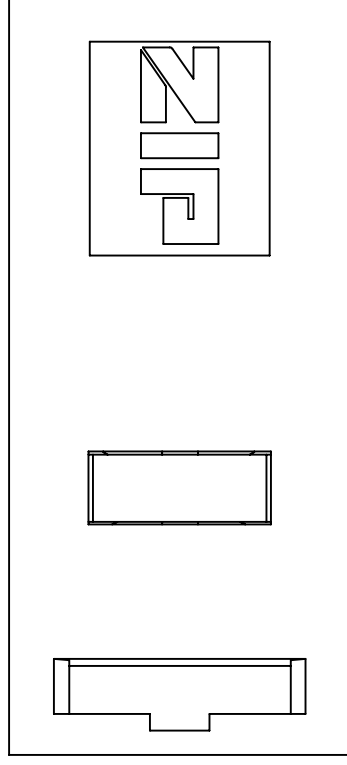

This page shows switch marking only.

此頁僅顯示開關印字，外觀參照外觀圖

Marking will be randomly on side A or side B

印字可為A面或B面

Marking can either be printed or molded

印字可為印刷或模刻

VIEW		SIZE	UNIT	mm
DATE	2020.11.06	VER.	2.0	DF-03
APPROVAL	沈俊榮	CONFIRM	張奕鉸	張立人

CAUTIONS:

注意事項

1: To secure the switch, please use an M2 small screw on a flat surface and tighten with plane washers or spring washers to securely mount the switch, using a maximum torque of 0.1 N·m.
若使用定位孔型式上蓋，請使用M2小型螺絲固定在平面上，並使用平墊圈或者彈性墊圈以便安全的鎖固開關，鎖固扭力請勿超過0.1 Nm。

2: To ensure the best performance of the switch, when handling/installing the switch, please do not apply uneven pressure to the direction indicated by the arrow in Figure 1. Any uneven pressure or pressure direction other than the operating direction might be harmful or damage the switch performance.

為確保開關正常運作，安裝及取用開關時，請勿直接施加壓力在圖-1中箭頭所指示的方向。如圖所示，任何不對稱的壓力或作動方向以外的壓力都不適用在開關按柄上。

3: Do not exceed the end position (EP) and over travel (OT). This could cause operation failure.

圖示設計按壓位置，請勿超過開關下死點及超出行程，以避免開關失效。

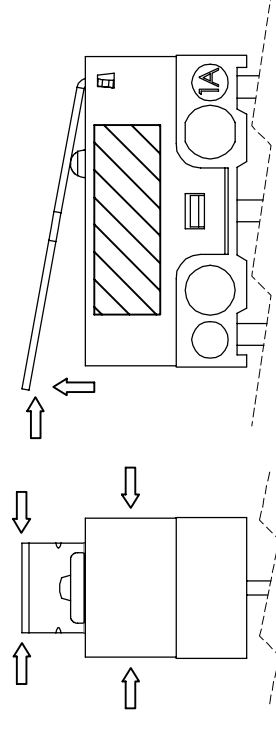



Figure-1

△	DATE	APPROVAL	DESIGN	ENGINEERING CHANGE DESCRIPTION	VIEW		SIZE	A4	UNIT	mm
					DATE	2019.12.17	VER.	1.0	FILE NAME	DF-CAUTIONS
					APPROVAL	倪有庭	CONFIRM	歐大揮	DESIGN	簡永鎮