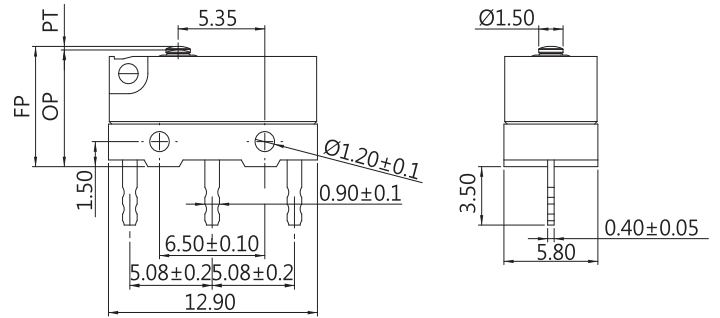

DIMENSIONS

 Unless otherwise specified, a tolerance of $\pm 0.4\text{mm}$ applies to all dimensions.

DFW SERIES

SPECIFICATIONS
Contact Resistance (initial)

 Max. 100m Ω

(Measured by ohm meter-Open Voltage < 1VDC, Driver current-100mA)

Insulation Resistance (at 500VDC/minute)

 Min. 100M Ω
Dielectric Strength

Min. 500VAC(50-60HZ)/minute between Live parts.

Min. 1500VAC(50-60HZ)/minute between Live parts and dead metal parts

Operating Temperature Range

-40°C to 85°C (with no icing)

Vibration

10~55Hz, displacement 0.75 mm (p-p)

Electrical Service Life

Min. 10,000 operations

Electrical Operating Frequency

10~30 operations per minute

Mechanical Service Life

Min. 1,000,000 operations

Mechanical Operating Frequency

120 operations per minute

Operating application of the switch

Set the switch pushing distance from 60% to 90% of the specified OT value

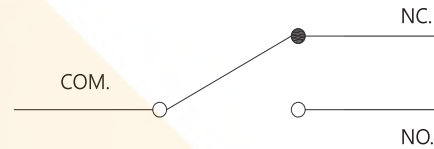
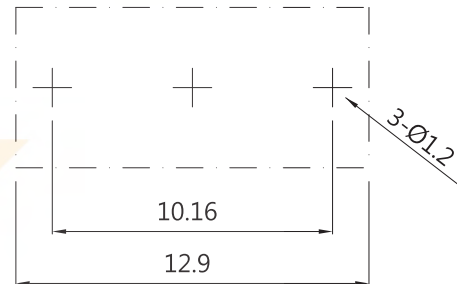
CONTACT CONFIGURATION

MOUNTING HOLES

P Type

TYPICAL APPLICATIONS

Fire Call Points and Security Systems, Automotive (Operation systems, engine area, interior), HEVAC, Communications Equipment, Industrial

CERTIFICATE INFORMATION

Model Name	UL, cUL	ENEC
DFW-P1	0.1RA 125/250VAC μ T85 1E4 3RA 24VDC μ T85 1E4	0.1A 125/250VAC μ T85 1E4 3A 24VDC μ T85 1E4
DFW-05	5RA 125/250VAC μ T85 1E4 3RA 24VDC μ T85 1E4	5A 125/250VAC μ T85 1E4 3A 24VDC μ T85 1E4

THE SELECTION OF RATING & FORCE

Model	Rating	L	S
DFW	0.1A	*	*
	5A	*	*

NOTE : The Symbol " * " to represent the result is accepted

TERMINAL TYPES

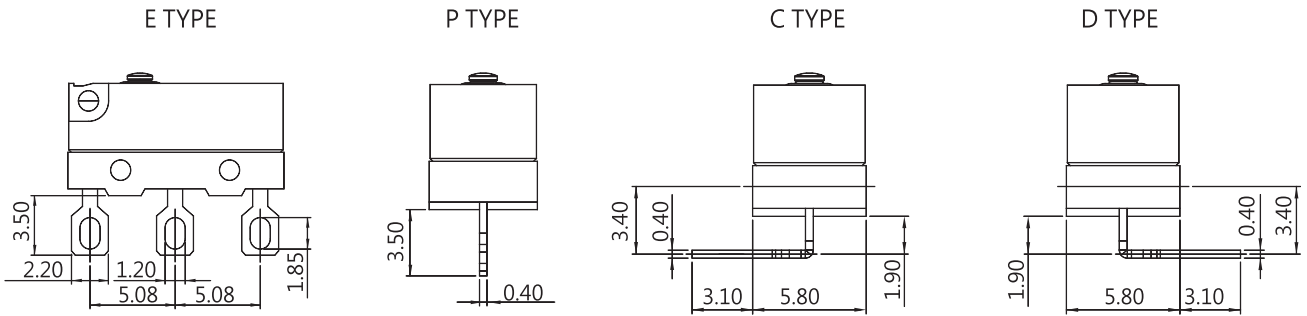

COVER TYPES

A type

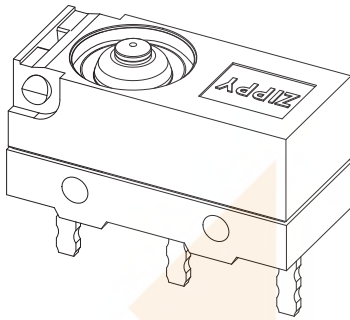





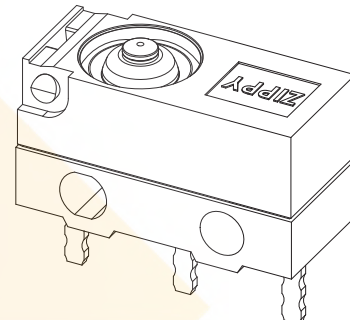







A type – Screw holes $\varnothing 1.2$ mm

E type



E type – Screw holes $\varnothing 2.05$ mm

ORDERING INFORMATION

D F W	0 5	S	B 0 1	P	0	A	Z
SERIES PREFIX	C O D E RATING CURRENT	C O D E OP R <small>E</small> ATING FORCE	C O D E ACTUATOR TYPE	C O D E TERMINAL TYPE	C O D E CIRCUIT ARRANGEMENT	C O D E COVER&CASE TYPE	ROHS CODE
	P1 0.1A 125/250VAC 05 5A 125/250VAC	S STANDARD L LIGHT	A00  A01  A02 	C  D  E  P 	0 S.P.D.T 1 S.P.S.T NO 2 S.P.S.T NC	A  E 	
			C O D E ACTUATOR TYPE B00  B01  B02 				

OPERATING CHARACTERISTICS (Internal snap-fit lever)

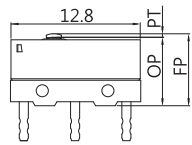
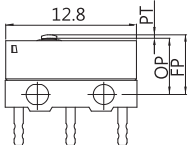
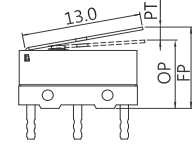
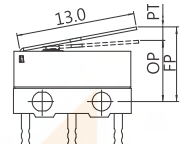
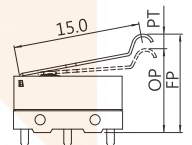
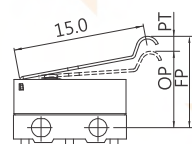
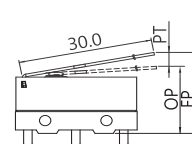
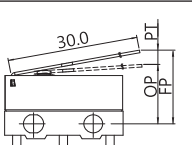
SWITCH TYPE	PART SUFFIX	OF Max. (gf)		OP (mm)	PT Max. (mm)	OT Min. (mm)	MD Max. (mm)	FP Max. (mm)	RF Min. (gf)
DFW- □□□ -A00 □ -Z		L	100	7.0 ± 0.2	0.5	0.2	0.12	7.5	21
		S	170						35
		L	100	5.9 ± 0.2	0.5	0.2	0.12	6.4	21
		S	170						35
DFW- □□□ -A01 □ -Z		L	32	8.2 ± 0.8	3.4	0.6	0.8	10.1	5
		S	56						8
		L	32	7.1 ± 0.8	3.4	0.6	0.8	9.0	5
		S	56						8
DFW- □□□ -A02 □ -Z		L	28	10.2 ± 0.8	3.5	0.7	0.92	14.2	5
		S	48						7
		L	28	9.1 ± 0.8	3.5	0.7	0.92	13.1	5
		S	48						7
DFW- □□□ -A09 □ -Z		L	15	9.5 ± 1.7	6.9	0.55	1.9	16.8	2
		S	24						3
		L	15	8.4 ± 1.7	6.9	0.55	1.9	15.7	2
		S	24						3

OPERATING CHARACTERISTICS (External snap-fit lever)

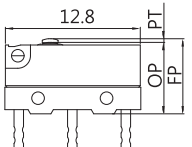
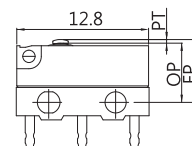
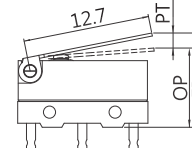
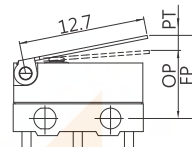
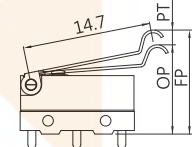
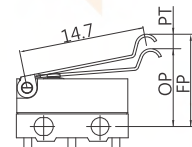
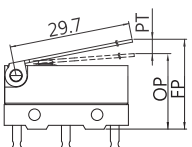
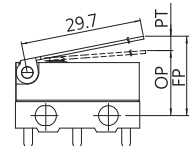
SWITCH TYPE	PART SUFFIX	OF Max. (gf)	OP (mm)	PT Max. (mm)	OT Min. (mm)	MD Max. (mm)	FP Max. (mm)	RF Min. (gf)	
DFW- □□□ -B00 □ -Z		L	100	7.0 ± 0.2	0.5	0.2	0.12	7.5	21
		S	170						35
		L	100	5.9 ± 0.2	0.5	0.2	0.12	6.4	21
		S	170						35
DFW- □□□ -B01 □ -Z		L	32	8.2 ± 0.8	3.4	0.6	0.8	10.1	5
		S	56						8
		L	32	7.1 ± 0.8	3.4	0.6	0.8	9.0	5
		S	56						8
DFW- □□□ -B02 □ -Z		L	28	10.2 ± 0.8	3.5	0.7	0.92	14.2	5
		S	48						7
		L	28	9.1 ± 0.8	3.5	0.7	0.92	13.1	5
		S	48						7
DFW- □□□ -B09 □ -Z		L	15	9.5 ± 1.7	6.9	0.55	1.9	16.8	2
		S	24						3
		L	15	8.4 ± 1.7	6.9	0.55	1.9	15.7	2
		S	24						3

DIMENSIONS

Unless otherwise specified, a tolerance of ±0.4mm applies to all dimensions.

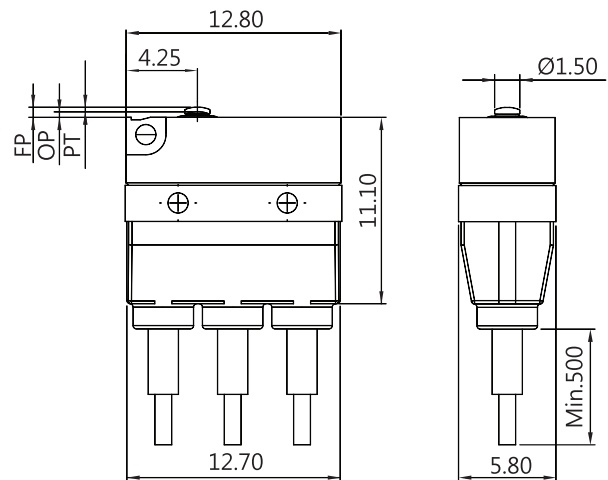

DFW (IP67) SERIES

TYPICAL APPLICATIONS

Automotive (Operation systems, engine area, interior),
HEVAC, Communications Equipment, Industrial

CERTIFICATE INFORMATION

Model Name	UL · cUL	ENEC
DFW-P1	0.1RA 125/250VAC μT85 1E4 3RA 24VDC μT85 1E4	0.1A 125/250VAC μT85 1E4 3A 24VDC μT85 1E4
DFW-05	5RA 125/250VAC μT85 1E4 3RA 24VDC μT85 1E4	5A 125/250VAC μT85 1E4 3A 24VDC μT85 1E4

ORDERING INFORMATION

DFW	05	S	B01	D	0	A	E	A	001	Z
SERIES PREFIX	CODE RATING CURRENT	CODE OPERATING FORCE	CODE ACTUATOR TYPE	CODE WIRE TYPE	CODE CIRCUIT ARRANGEMENT	CODE CASE & COVER TYPE	CODE AWG TYPE	CODE UL NUMBER	SERIAL CODE	ROHS CODE
	P1 0.1A 125/250VAC 05 5A 125/250VAC	S STANDARD L LIGHT	A00 A01 A02	D R L	0 S.P.D.T 1 S.P.S.T NO 2 S.P.S.T NC	A E	E 20 AWG F 22 AWG G 24 AWG	A UL1007 C UL1430 D UL1061		
			CODE ACTUATOR TYPE							
			B00 B01 B02							

OPERATING CHARACTERISTICS (Internal snap-fit lever)

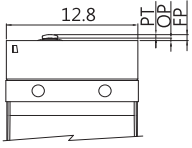
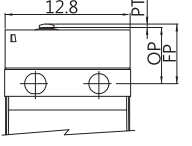
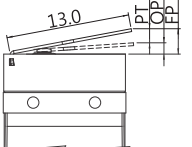
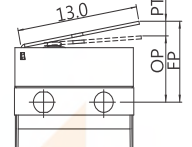
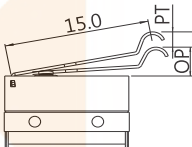
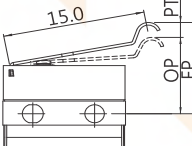
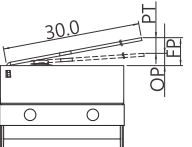
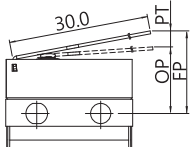
SWITCH TYPE	PART SUFFIX	OF Max. (gf)		OP (mm)	PT Max. (mm)	OT Min. (mm)	MD Max. (mm)	FP Max. (mm)	RF Min. (gf)
		L	S						
DFW- □□□ -A00 □ -Z		L	100	0.4 ± 0.2	0.5	0.2	0.12	0.9	21
		S	170						35
		L	100	5.9 ± 0.2	0.5	0.2	0.12	6.4	21
		S	170						35
DFW- □□□ -A01 □ -Z		L	32	1.6 ± 0.8	3.4	0.6	0.8	3.5	5
		S	56						8
		L	32	7.1 ± 0.8	3.4	0.6	0.8	9.0	5
		S	56						8
DFW- □□□ -A02 □ -Z		L	28	3.6 ± 0.8	3.5	0.7	0.92	7.6	5
		S	48						7
		L	28	9.1 ± 0.8	3.5	0.7	0.92	13.1	5
		S	48						7
DFW- □□□ -A09 □ -Z		L	15	2.9 ± 1.7	6.9	0.55	1.9	10.2	2
		S	24						3
		L	15	8.4 ± 1.7	6.9	0.55	1.9	15.7	2
		S	24						3

OPERATING CHARACTERISTICS (External snap-fit lever)

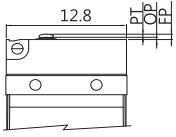
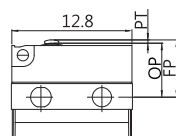
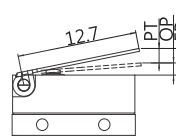
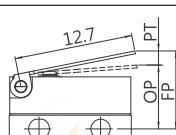
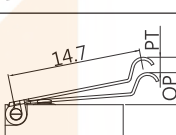
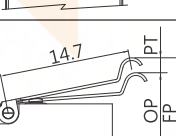
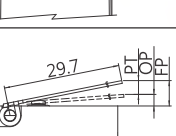
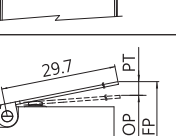
SWITCH TYPE	PART SUFFIX	OF Max. (gf)		OP (mm)	PT Max. (mm)	OT Min. (mm)	MD Max. (mm)	FP Max. (mm)	RF Min. (gf)
		L	S						
DFW- □□□ -B00 □ -Z		L	100	0.4 ± 0.2	0.5	0.2	0.12	0.9	21
		S	170						35
		L	100	5.9 ± 0.2	0.5	0.2	0.12	6.4	21
		S	170						35
DFW- □□□ -B01 □ -Z		L	32	1.6 ± 0.8	3.4	0.6	0.8	3.5	5
		S	56						8
		L	32	7.1 ± 0.8	3.4	0.6	0.8	9.0	5
		S	56						8
DFW- □□□ -B02 □ -Z		L	28	3.6 ± 0.8	3.5	0.7	0.92	7.6	5
		S	48						7
		L	28	9.1 ± 0.8	3.5	0.7	0.92	13.1	5
		S	48						7
DFW- □□□ -B09 □ -Z		L	15	2.9 ± 1.7	6.9	0.55	1.9	10.2	2
		S	24						3
		L	15	8.4 ± 1.7	6.9	0.55	1.9	15.7	2
		S	24						3