

1

2

3

4

Notes: (Unless Otherwise Specified)

- 1. Waterproof Rate : IP68.
- 2. Recommend Panel Thickness : 0.8 to 4.0 mm.
- 3. Recommend Torque: 9~10 Kgf-cm.
- 4. RoHS Compliant.

REV	ECN#	DESCRIPTION OF REVISION	DRAW BY DATE	CHECK BY DATE	APPROVE BY DATE
A0		Mass Production	Joyce 10/04/12	Lucas 10/04/12	Ray 10/04/12

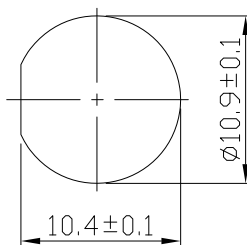
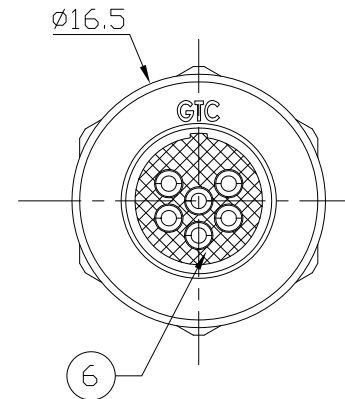
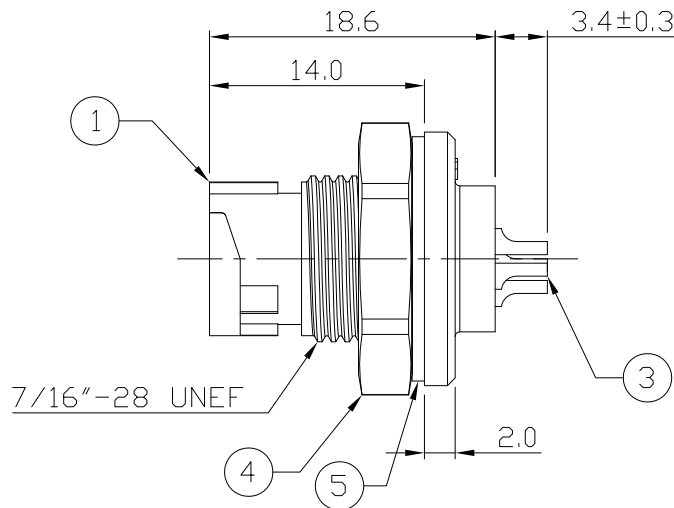
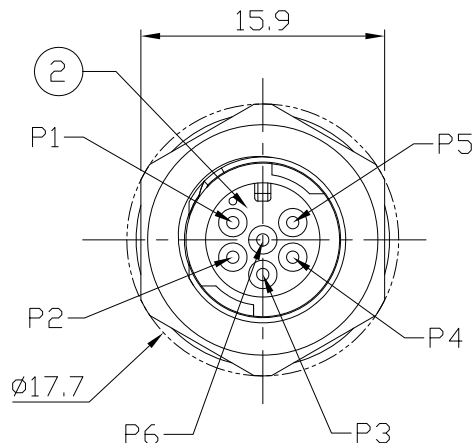

Recommended Panel Cut-Out

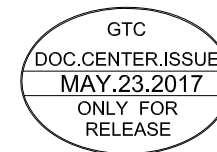

6	Glue	Epoxy Color: Black	
5	Gasket	Silicone Color: Black	1
4	Metal Hex Nut	Copper Alloy Finish: Ni Plated	1
3	Contacts	Copper Alloy Finish: Au Plated	6
2	Housing	Thermoplastic Color: Black	1
1	Metal Body	Zn Alloy Finish: Ni Plated	1
Item	Part Name	Material / Finish	Q'ty

TITLE						DRAWING NUMBER			REV.
C1 Metal 2A 6P Panel Male Solder Lock						GT251210-01060			A0
	B	1:1	Joyce 10/04/12	Lucas 10/04/12	Ray 10/04/12	X.X ± 0.5 X.XX ± 0.2	X.XXX ± 0.05 ANGLES ± 1°	mm	1/1
THIRD ANGLE PROJECTION	SIZE	SCALE	DRAW / DATE	CHECK / DATE	APPROVE / DATE	TOLERANCES		UNIT	SHEET

GT Contact CO.,LTD

NOTICE OF PROPRIETARY PROPERTY:
 THE INFORMATION CONTAINED HEREIN IS THE PROPRIETARY PROPERTY OF GT Contact CO.,LTD THE POSSESSOR AGREES TO THE FOLLOWING:
 (a) TO MAINTAIN THIS DOCUMENT IN CONFIDENCE
 (b) NOT TO REPRODUCE OR COPY IT
 (c) NOT TO REVEAL OR PUBLISH IT IN WHOLE OR PART
 (d) ALL RIGHTS RESERVED

1

2

3

4