

MICRO SWITCHES

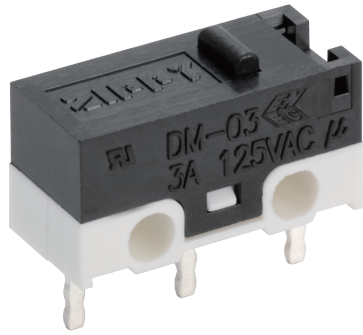

DIMENSIONS

Unless otherwise specified, a tolerance of $\pm 0.4\text{mm}$ applies to all dimensions.

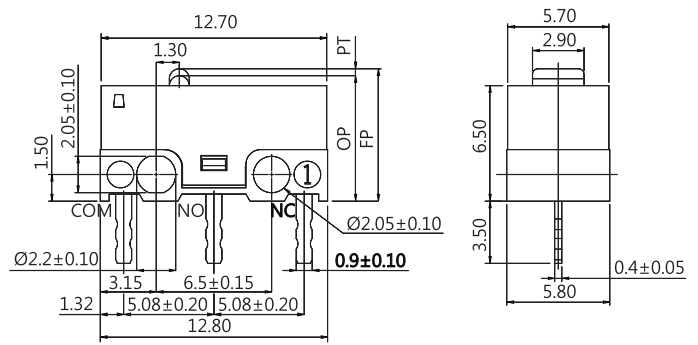

DM SERIES

SPECIFICATIONS

Contact Resistance(initial)

Max. 100 m Ω

Measured by ohm meter - open voltage < 1VDC, driver current -100 mA

Insulation Resistance (at 500 VDC / minute)

Min. 100 M Ω

Dielectric Strength

Min. 1000VAC(50-60HZ)/minute between Live parts.

Min. 1500VAC(50-60HZ)/minute between Live parts and dead metal parts

Operating Temperature Range

-40°C to 65°C (with no icing)

Vibration

10~55Hz, displacement 0.75 mm (p-p)

Electrical Service Life

0.1A, 0.2A - Min. 1,000,000 operations

3A - Min. 10,000 operations

Electrical Operating Frequency

10~30 operations per minute

Mechanical Service Life

Min. 1,000,000 operations

Mechanical Operating Frequency

120 operations per minute

Operating application of the switch

Set the switch pushing distance from 60% to 90% of the specified OT value

CONTACT CONFIGURATION

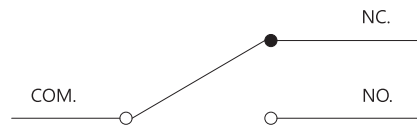

MOUNTING HOLES

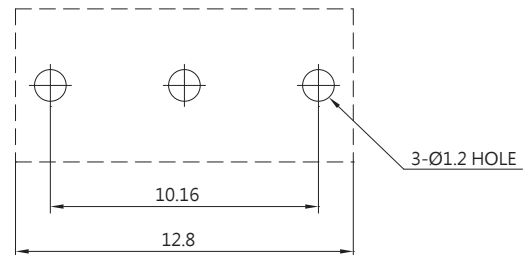

CERTIFICATE INFORMATION

Model Name	UL, cUL	ENEC
DM-03	0.1A 48VDC 0.2A 60VDC 0.1A 125VAC 3A 125VAC (Temp:65°C) Min. 10,000 operations	3A 125VAC μ T55 1E4

APPLICATIONS

Walkie talkie, Mouse, Electric knife, Electric stapler, Telephone, Calculator, Mixer & chopper, Electric pan, Battery charger, Video cassette reminder, Cordless phone, Tester machine

THE SELECTION OF RATING & FORCE

Model	Rating	L	S
DM	0.1A	*	*
	0.2A	*	*
	3A	*	*

NOTE : The Symbol " * " to represent the result is accepted

TERMINAL TYPES

C TYPE

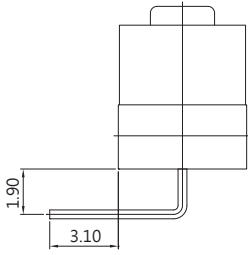

D TYPE

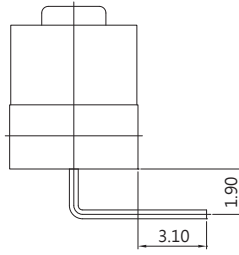

E TYPE

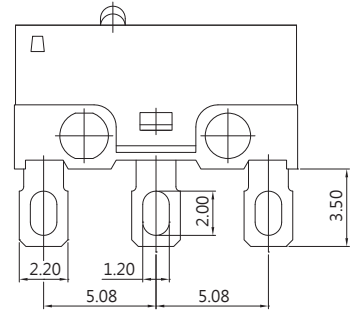

F TYPE

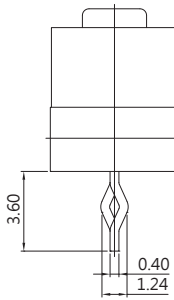

P TYPE

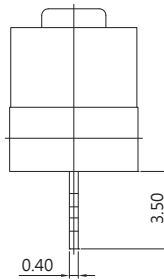

ORDERING INFORMATION

D	M	—	0	3	—	S	—	0	—	P	—	Z
SERIES PREFIX			RATING CURRENT			OPERATING FORCE		ACTUATOR TYPE		TERMINAL TYPE		ROHS CODE
			03	3A 125VAC		L	LIGHT	0		C		
			P1	0.1A 48VDC 0.1A 125VAC		S	STANDARD	1		D		
								2		E		
								3		F		
								4		P		
								5				
								6				
								7				
								8				
								9				

Note1.
for special type DM-03□-□□-A gold plated contacts
rating 0.1A 48VDC ; 0.1A 125VAC ; 0.2A 60VDC ;
1A 125VAC ; 3A 125VAC.

OPERATING CHARACTERISTICS

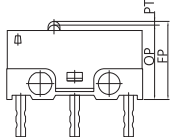
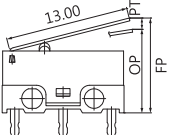
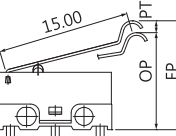
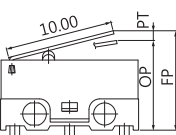
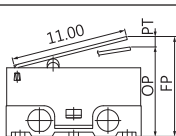
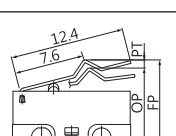
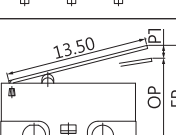
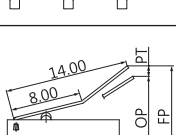
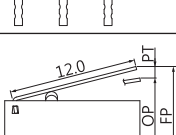
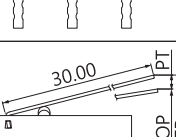
SWITCH TYPE	PART SUFFIX	OF Max. (gf)		OP (mm)	PT Max. (mm)	OT Min. (mm)	MD Max. (mm)	FP Max. (mm)	RF Min. (gf)
		L	S						
DM-03 □ -0 □ -Z		L	90	7.0±0.3	1.3	0.2	0.3	8.0	15
		S	150						20
DM-03 □ -1 □ -Z		L	30	8.4±0.8	3.4	0.6	1.3	11.0	5
		S	50						8
DM-03 □ -2 □ -Z		L	27	10.5±0.8	3.8	0.6	1.5	13.5	4
		S	45						7
DM-03 □ -3 □ -Z		L	40	7.9±0.8	3.4	0.6	1.0	10.5	6
		S	70						10
DM-03 □ -4 □ -Z		L	36	8.1±0.8	3.4	0.6	1.1	10.7	5
		S	65						9
DM-03 □ -5 □ -Z		L	53	8.9±0.8	2.9	0.6	0.8	11.0	8
		S	88						12
DM-03 □ -6 □ -Z		L	29	8.5±0.8	3.5	0.7	1.4	11.2	4
		S	50						7
DM-03 □ -7 □ -Z		L	29	11.3±1.0	3.7	0.3	1.4	14.0	4
		S	50						7
DM-03 □ -8 □ -Z		L	33	8.2±0.8	3.4	0.5	1.2	10.8	5
		S	60						8
DM-03 □ -9 □ -Z		L	15	10.79±2.1	10.1	0.9	3.0	16.9	2
		S	22	8.9±2.1					3